

Compact Disc Player

Operating Instructions



*CDP-C77ES
CDP-C87ES*

WARNING

To prevent fire or shock hazard, do not expose the unit to rain or moisture.

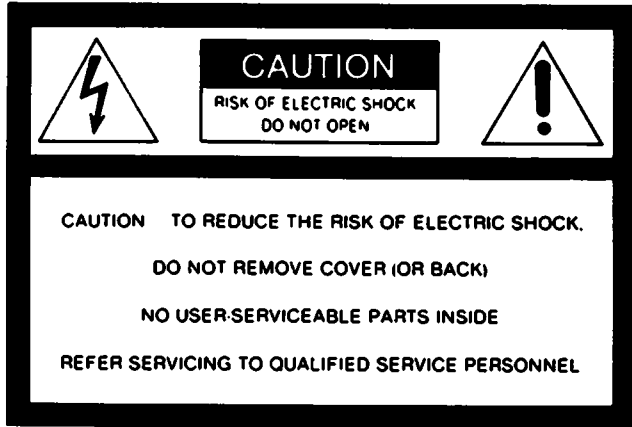

This symbol is intended to alert the user to the presence of uninsulated "dangerous voltage" within the product's enclosure that may be of sufficient magnitude to constitute a risk of electric shock to persons.



This symbol is intended to alert the user to the presence of important operating and maintenance (servicing) instructions in the literature accompanying the appliance.

INFORMATION

This equipment generates and uses radio frequency energy and if not installed and used properly, that is, in strict accordance with the manufacturer's instructions, may cause interference to radio and television reception. It has been type tested and found to comply with the limits for a Class B computing device in accordance with the specifications in Subpart J of Part 15 of FCC Rules, which are designed to provide reasonable protection against such interference in a residential installation. However, there is no guarantee that interference will not occur in a particular installation. If this equipment does cause interference to radio or television reception, which can be determined by turning the equipment off and on, the user is encouraged to try to correct the interference by one or more of the following measures:

Reorient the receiving antenna

Relocate the equipment with respect to the receiver

Move the equipment away from the receiver

Plug the equipment into a different outlet so that equipment and receiver are on different branch circuits.

If necessary, the user should consult the dealer or an experienced radio/television technician for additional suggestions. The user may find the following booklet prepared by the Federal Communications Commission helpful:

"How to Identify and Resolve Radio-TV Interference Problems".

This booklet is available from the U.S. Government Printing Office, Washington, DC 20402, Stock No. 004-000-00345-4.

Owner's Record

The model and serial numbers are located at the rear. Record these numbers in the spaces provided below. Refer to these numbers whenever you call upon your Sony dealer regarding this product.

Model No. _____ Serial No. _____

For the customers in Australia

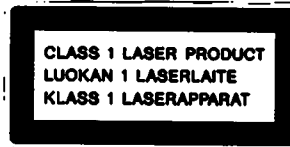

This Compact Disc player is classified as a CLASS 1 LASER product. The CLASS 1 LASER PRODUCT label is located on the rear exterior.

Differences by Model

This instruction manual covers the CDP-C77ES and the CDP-C87ES. Their performance and operation is identical except for the following:

CDP-C87ES comes with a SERIAL CHAIN terminal and CONTROL S IN/OUT terminals.

Note on the Transit Key

The transit key and the red lock screw (CDP-C87ES only) on the bottom exterior of the unit protects the optical system against shock during transportation. Before operating the CD player, be sure to remove the key and red lock screw (CDP-C87ES only) by following the instructions on the label, and store it in a safe place.

When transporting the unit, replace the key and red lock screw (CDP-C87ES only) in its original hole and lock it in place.

Re-install the red lock screw

1. Open the disc compartment by pressing the OPEN/CLOSE button.
2. Press the DISC SKIP button until disc tray 1 is at the front.
3. Close the disc compartment by pressing the OPEN/CLOSE button.
4. Wait for the (DISC 1) indicator to blink before turning the power off. Re-install the transporting lock screw.

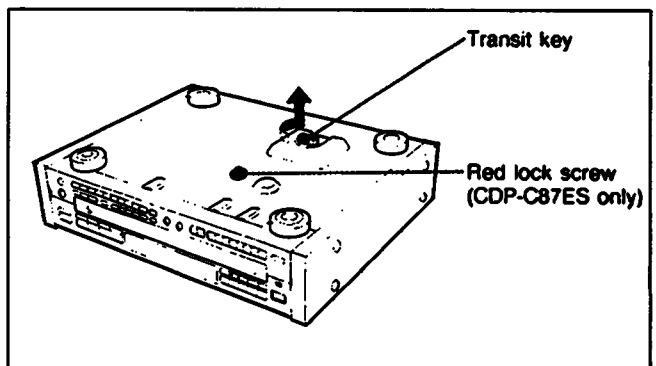

Table of Contents

Warning	2
Introducing this CD player	3
Installing the CD player	4
Maintenance	4
Precautions	4
Connections	5
Location of controls	6
Front panel	6
Remote commander	7
Preparing the remote commander	7
Installing batteries	7
Playing a disc – Continuous play	8
Information display	9
Selecting a desired disc	10
Locating a particular selection	10
Locating a particular point in a selection	10
Playing in a random order – Shuffle play	11
To play only the desired discs in a random order	
– Select shuffle play	11
Playing in a desired order – Program play	12
Designating the playing time – Program edit	12
Checking the programmed selections	13
Clearing the programmed selections	13
Designating the total playing time – Time edit	14
Convenient features for tape recording	16
Fading in/Fading out	16
Fading out after a desired duration – Time fade	16
Locating the loudest portion of the disc	
– Peak search	17
Playing repeatedly – Repeat play	18
Playing the beginning of each selection	
– Music scan	19
Enhanced surround effects – Digital signal processor	20
Memorizing a DSP mode	21
On custom files	22
Keeping the program in memory – Bank	23
Memorizing a bank	23
Playing the disc using the bank	23
Clearing the bank	23
Assigning names to a disc – Disc Memo	24
Displaying the memos	25
Clearing the disc memo	25
Preset the desired output level to a disc	
– Level File	26
Clearing the level file	26
Timer activated playing	27
Activating the power with an audio timer	27
Connect two players and for more listening enjoyment – Serial chain control (CDP-C87ES only)	28
Specifications	30
Troubleshooting guide	31

Introducing This CD Player

This unit is equipped with 5 disc trays which allow you to choose from a large number and wide variety of selections. Any disc at any time can be played using the DISC 1 to 5 buttons.

Enjoy listening in various playing modes

You can select the playing modes among the following:

- | | |
|--------------------------|---|
| Continuous play (page 8) | – The entire disc(s) is played once. |
| Shuffle play (page 11) | – Selections are played in a random order. |
| Program play (page 12) | – Selections are played in your desired order. |
| Repeat play (page 18) | – Selections or portions are played repeatedly. |

Editing your own tapes

- You can fade the play in or out when making your own tape recording. – Fade in/Fade out (page 16)
- You can confirm the total playing time while choosing the selections to be programmed. – Program edit (page 12)
- The player can program selections automatically to fit in a desired duration. – Time edit (page 14)
- You can stop the play, fading out at the time desired. – Time fade (page 16)
- The loudest portion of the disc will be determined and played repeatedly. – Peak search (page 17)

Making your disc custom-made – CUSTOM FILE function

- You can assign a name to a disc, such as the title of the disc or the date of purchase. – Disc memo (page 24)
- You can select and store specific acoustic surround effects for an individual disc. – DSP file (page 21)
- You can store the programmed playing order for a disc. – Bank (page 23)
- You can store the optimum playback level of each disc in the unit's memory. – Level file (page 26)

You can play a beginning of each selection – Music scan

You can check the selections by scanning the beginning of each selection in the disc. You can use this function in any play mode. (page 19)

Enjoy listening in various acoustic atmospheres

The DIGITAL SIGNAL PROCESSOR (DSP) lets you listen to selections according to various acoustic atmospheres. (page 20)

Easy-to-see display

The selection number, the playing time and the remaining time are displayed by pressing the TIME/MEMO button. And also playing modes like repeat, shuffle, program and bank are displayed in the display window.

To operate two CD players serially – Serial chain control (CDP-C87ES only)

Serial chain gives you control over two players for more listening enjoyment. (page 28)



This indicates a function operated only from the remote commander.



This indicates a function operated only on the main unit.

Installing the CD Player

Notes on Installation

- Place the unit in a location with adequate air circulation to prevent internal heat build up in the unit.
- Do not place the unit on a soft surface, such as a rug that would block the ventilation holes on the bottom.
- Do not install the unit.
 - near heat sources such as radiators or air ducts.
 - in a place subject to direct sunlight, excessive dust, mechanical vibration or shock.
- Use on level surface. Make sure that the unit is placed in a proper location before switching the power on.
- Do not transport the unit with the discs inserted.
- If you remove the side panels to install the unit in a rack, be sure to secure the metal casing with the supplied screws (M3×8 mm in length). DO NOT use the longer screws that held the side panels in place.

On moisture condensation

If the player is brought directly from a cold to a warm location, or is placed in a very damp room, moisture may condense on the lens inside the unit. Should this occur, the player will not operate. In this case, remove the disc and leave the player turned on for about an hour until the moisture evaporates.

Maintenance

Cleaning the cabinet

Clean the cabinet, panel and controls with a soft cloth lightly moistened with mild detergent solution. Do not use any type of abrasive pad scouring powder or solvent such as alcohol or benzine.

Cleaning discs

Before playing, clean the disc with the cleaning cloth. Wipe the disc from the center out.



Do not use solvents such as benzine, thinner, commercially available cleaners or anti-static spray intended for analog discs.

After playing, store the disc in its case.

Precautions

On Safety

- Check the unit's operating voltage before operation. It must be identical with that of your local power supply. The operating voltage is indicated on the nameplate at the rear of the unit.
- Should any liquid or solid object fall into the cabinet. Unplug the unit and have it checked by qualified personnel before operating it any further.
- Unplug the unit from the wall outlet if it will not be used for a long time. To disconnect the cord, pull it out by grasping the plug. Never pull the cord itself.
- As the laser beam used in this compact disc player is harmful to the eyes, do not attempt to disassemble the cabinet. Refer servicing to qualified personnel only.

On operation

When the unit is not used, turn the power off to conserve energy and to extend the useful life of your unit.

Important

Since the CD system boasts a wide dynamic range, the peaks of high level inputs are recorded with high fidelity, and the noise level is very low.

Do not turn up the volume while listening to a portion with no audio signals or very low level inputs if you do, the speakers may be damaged when a peak level portion is played.

For detailed safety precautions, see the leaflet "IMPORTANT SAFEGUARDS".

If you have any questions or problems concerning your unit, please contact your nearest Sony dealer.

Connections

For Correct Connections

- Turn off the power of each unit before making connections.
- Connect the AC power cord last.
- Be sure to insert the plugs firmly into the jacks. Loose connection may cause hum and noise.
- Leave a little slack in the connecting cord to allow for inadvertent shock or vibration.
- Cord plugs and jacks are color coded: Red plugs and jacks are for the right channel (R) and white ones for the left channel (L).

To Connect to an Amplifier

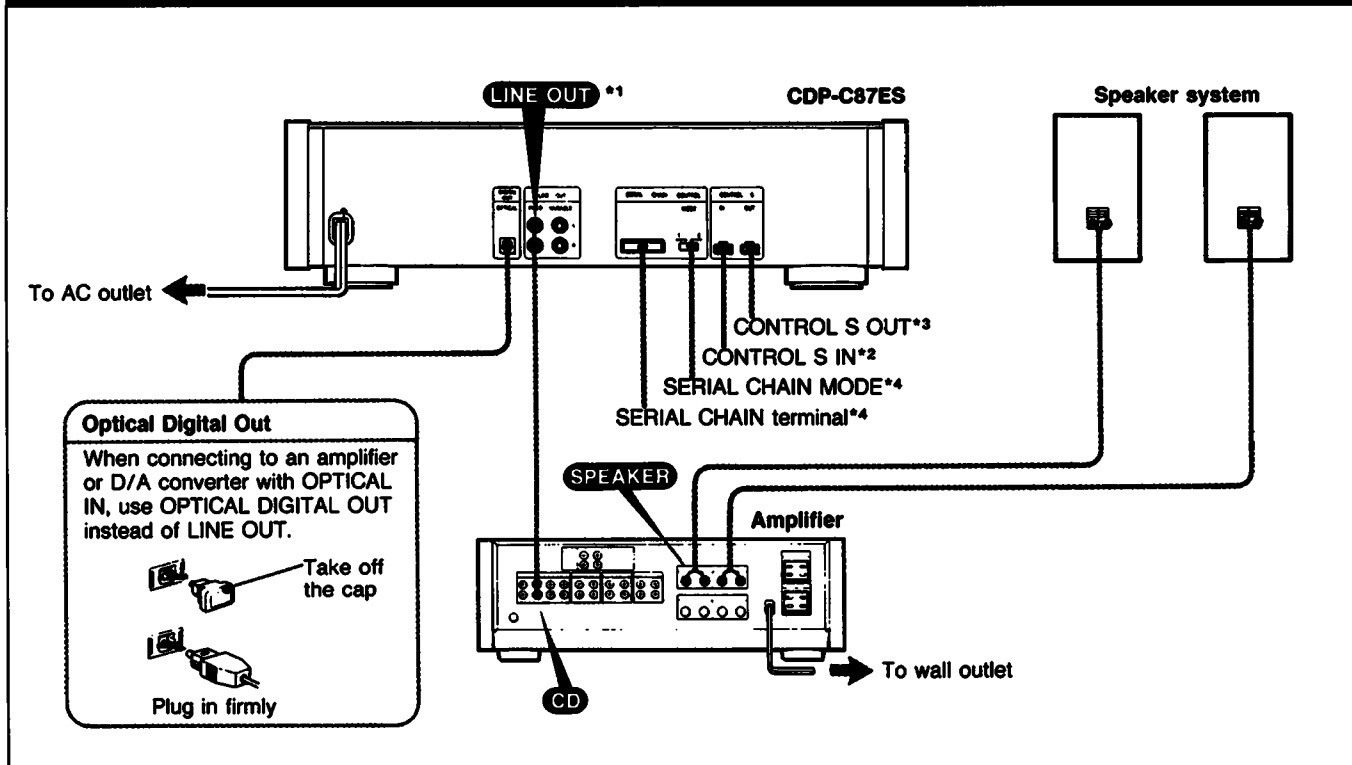

*1Notes on LINE OUT

FIXED: The output level is fixed.

VARIABLE: The output level can be adjusted with LINE OUT/PHONE LEVEL control or LINE OUT LEVEL buttons on the remote commander. However, if the LINE OUT/PHONE LEVEL control is turned while recording, the recording level will change even when it is preset on the tape deck.

*2Note on the CONTROL S IN (input)

To remote control this unit through a CD player, receiver or amplifier, connect the input on this unit to the CONTROL S OUT (output) on a Sony CD player, receiver or amplifier, with a CONTROL S cable.

*3Note on the CONTROL S OUT (output) (CDP-C87ES only)

To remote control another CD player (supporting the Serial Chain feature) through this unit, connect the output on this unit to CONTROL S IN (input) on the other unit with a CONTROL S cable.

Note on optical digital out

Connect the optical out to the amplifier with the optical input or D/A converter. When you connect, use the connecting cable for optical out POC-15 (not supplied). When the optical out is connected, you cannot use fade out, fade in, DSP mode and time fade function.

*4Note on the SERIAL CHAIN terminal and MODE selector (CDP-C87ES only)

Use both serial chain terminals to control two CD players serially. See page 28 for details.

Location of Controls

Front Panel

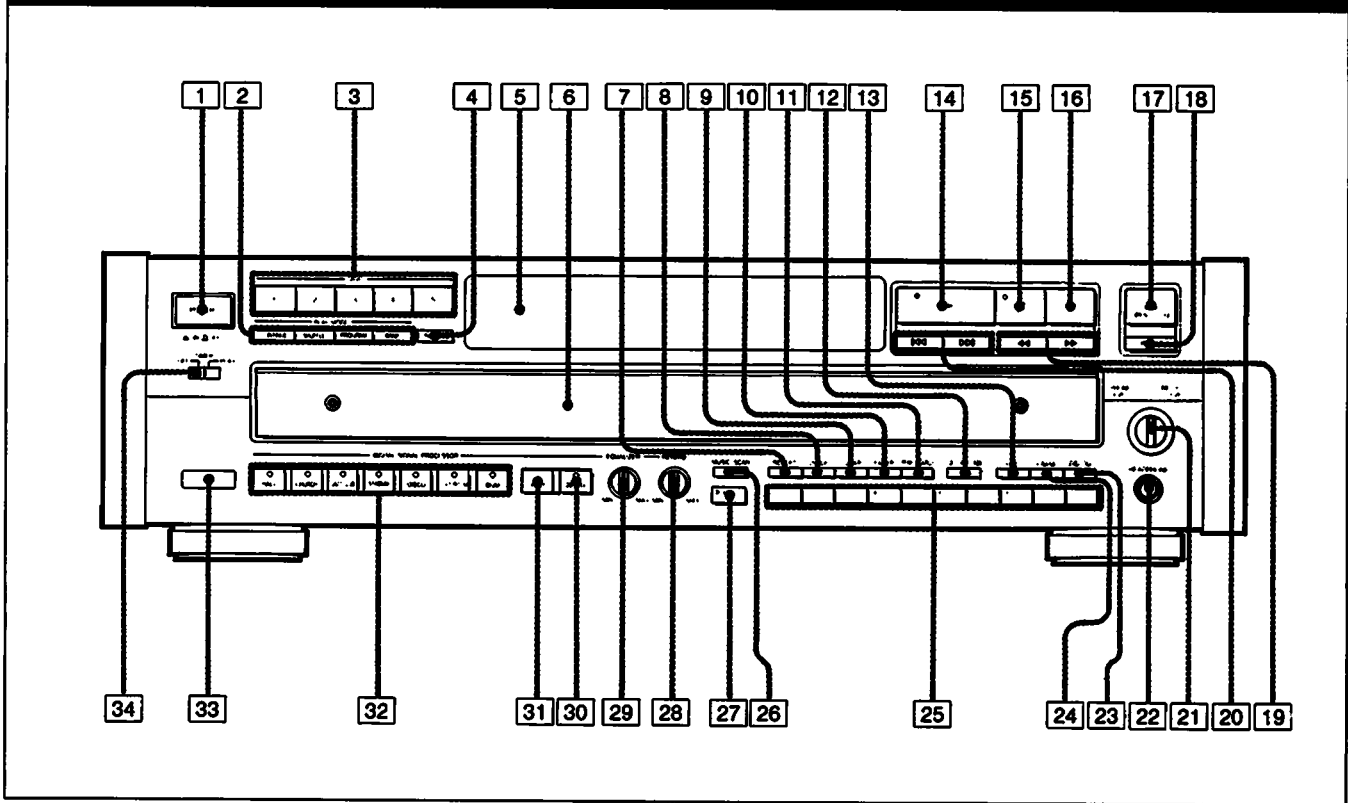

Refer to the pages indicated in ● for details.

- | | |
|---|---|
| <ul style="list-style-type: none"> 1 POWER switch ● 2 PLAY MODE buttons CONTINUE button ● SHUFFLE button ● PROGRAM button ● BANK button ● 3 DISC 1-5 buttons ● 4 TIME/MEMO button ● 5 Display window ● 6 Disc tray ● 7 REPEAT button ● 8 CHECK button ● 9 CLEAR button ● 10 FADER button ● 11 PEAK SEARCH button ● 12 EDIT/TIME FADE button ● 13 FILE button ● 14 ►(play) button ● 15 (pause) button ● 16 ■ (stop) button ● 17 ▲ OPEN/CLOSE button ● | <ul style="list-style-type: none"> 18 DISC SKIP button ● 19 ◀▶ (manual search) buttons ● 20 ◀▶▶ (AMS*) buttons ● 21 PHONE LEVEL/LINE OUT LEVEL control ● 22 HEADPHONES jack ● 23 LEVEL FILE button ● 24 ERASE button ● 25 Track buttons ● 26 MUSIC SCAN button ● 27 > 10 (over 10) button ● 28 DSP REVERB level control ● 29 DSP EQUALIZER level control ● 30 DSP FILE button ● 31 FLAT button 32 DSP mode buttons BGM button ● LIVE ROOM button ● DISCO button ● STADIUM button ● JAZZ CLUB button ● CHURCH button ● HALL button ● 33 Remote sensor 34 TIMER switch ● |
|---|---|

* AMS is the abbreviation Automatic Music Sensor.

Remote Commander

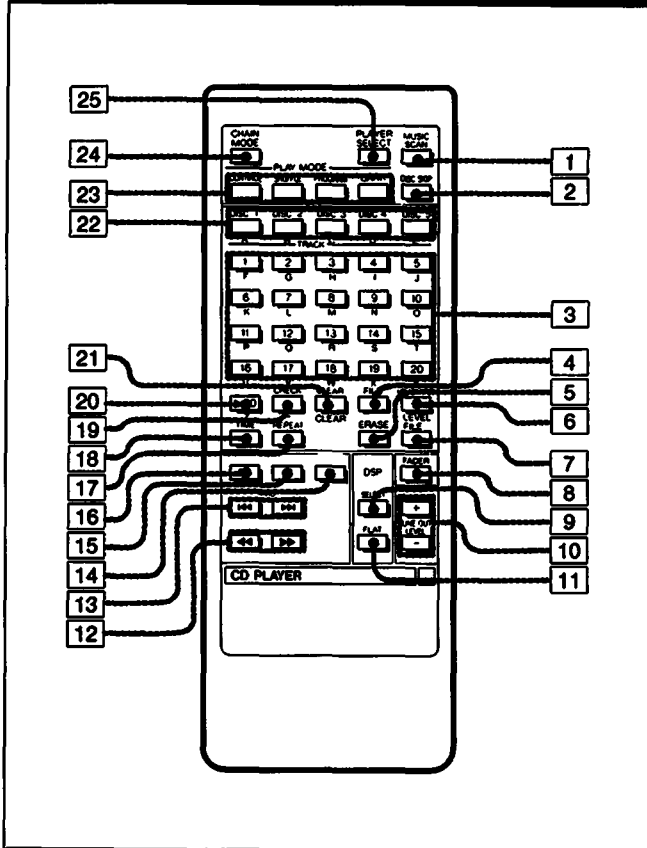

Refer to the pages indicated in ● for details.

- 1 MUSIC SCAN button ●
- 2 DISC SKIP button ●
- 3 Track buttons ●
- 4 FILE button ●
- 5 ERASE button ●
- 6 MEMO INPUT button ●
- 7 LEVEL FILE button ●
- 8 FADER button ●
- 9 DSP SELECT button ●
- 10 LINE OUT LEVEL buttons ●
- 11 DSP FLAT button ●
- 12 ◀▶▶▶ (manual search) buttons ●
- 13 ◀▶▶▶ (AMS) buttons ●
- 14 ■ (stop) button ●
- 15 || (pause) button ●
- 16 ▶ (play) button ●
- 17 REPEAT button ●
- 18 TIME button ●
- 19 CHECK (program check) button ●
- 20 > 20 (over 20) button ●
- 21 CLEAR (program clear) button ●
- 22 DISC 1-5 buttons ●
- 23 PLAY MODE buttons
 CONTINUE button ●
 SHUFFLE button ●
 PROGRAM button ●
 BANK button ●
- 24 CHAIN MODE button (CDP-C87ES only) ●
- 25 PLAYER SELECT button (CDP-C87ES only) ●

Buttons with yellow letters (A, B, C,) are for writing a disc memo (page 24).

Preparing the Remote Commander

Installing Batteries

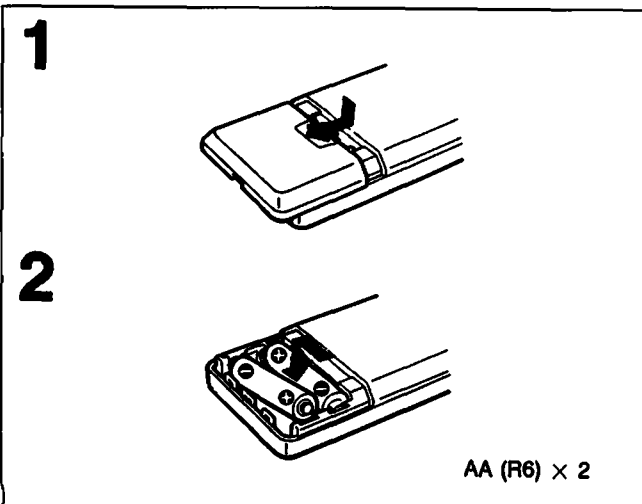

On battery life

- About half a year of normal operation can be expected when using the Sony SUM-3(NS) batteries.
- When the batteries are run down, the remote commander will not operate the unit. In this case, replace both batteries with new ones.

Notes on the remote commander and remote control operation

- Keep the commander away from extremely hot or humid places.
- Avoid dropping any foreign objects into the commander casing, particularly when replacing the batteries.
- Avoid exposing the remote sensor to direct sunlight or lighting apparatus. Such exposure can cause a malfunction.
- To avoid damage caused by battery leakage and corrosion, remove the batteries when the commander will not be used for a long time.

Playing a Disc – Continuous Play

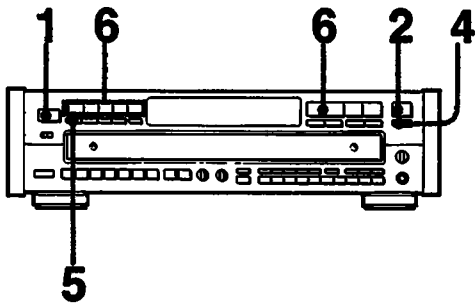

1

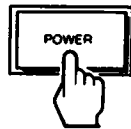

2

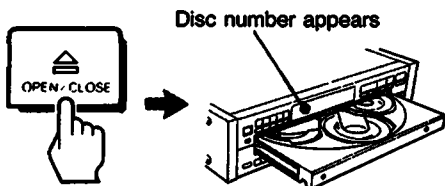

3

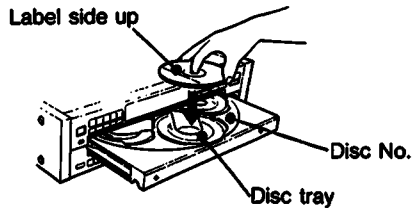

4

To play more than one disc, place additional discs on the tray in the desired order.

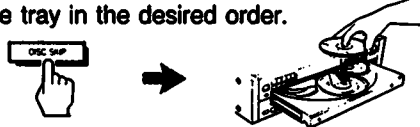

5

Choose whether to play one disc (1 DISC) or all discs (ALL DISCS).

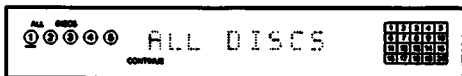

6

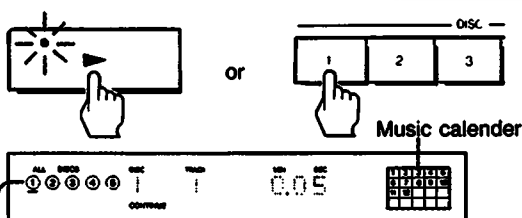

When all selections of a disc are played, the circle on the tray number goes off.

Before playing a disc, turn on the amplifier and set the input selector to the CD player position.

To stop play

To stop for a moment during play, press .

Press or to resume play.

To stop play, press .

To stop play and open the compartment, press .

Caution on adjusting volume

Do not turn up the volume while listening to a portion with very low level inputs or no audio signals. If you do, the speakers may be damaged when a peak level portion is played.

To listen with the headphones

Connect the headphones and control the volume with PHONE LEVEL/LINE OUT LEVEL control or LINE OUT LEVEL buttons on the remote commander.

Notes

- Disc memo (see page 24) appears in the display window during the stop mode. If the disc memo is not stored, the disc number – such as “*DISC-1*”, is displayed.
- The tray number of an empty tray will be displayed until the empty tray number is set to play. Once they are recognized empty, they will disappear.
- “- NO DISC -” is displayed when all trays are empty. You can put another title for “- NO DISC -” display. See page 24 for procedure.
- Place an empty tray in the front loading position, and put the disc in it. If you insert the disc into a tray other than the one in the front, the unit may not be able to find the disc. Be sure to use DISC SKIP to rotate to the next empty tray.

Notes on handling discs

- To keep the disc clean, handle the disc by its edge. Do not touch the surface.
- Do not stick paper or tape on the disc.



- Do not expose the disc to direct sunlight or heat sources such as hot air ducts, or leave it in a car parked in direct sunlight as there can be a considerable rise in the temperature.
- After playing, store the disc in its case.

To play an (3-inch) 8 cm CD

Place it on the inner circle of the tray. If the disc is provided with an adaptor, first remove it. Do not put a normal CD (12 cm/ 5-inch) on top of an 8 cm CD.

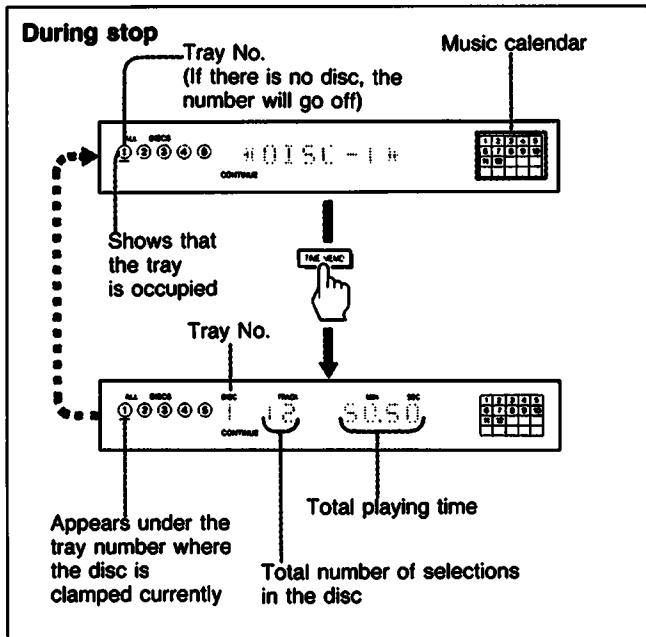

Information Display

When you press \square OPEN/CLOSE or the disc tray itself to close the tray, the total number of selections and the total playing time of the disc will be displayed after the disc memo or disc number is displayed.

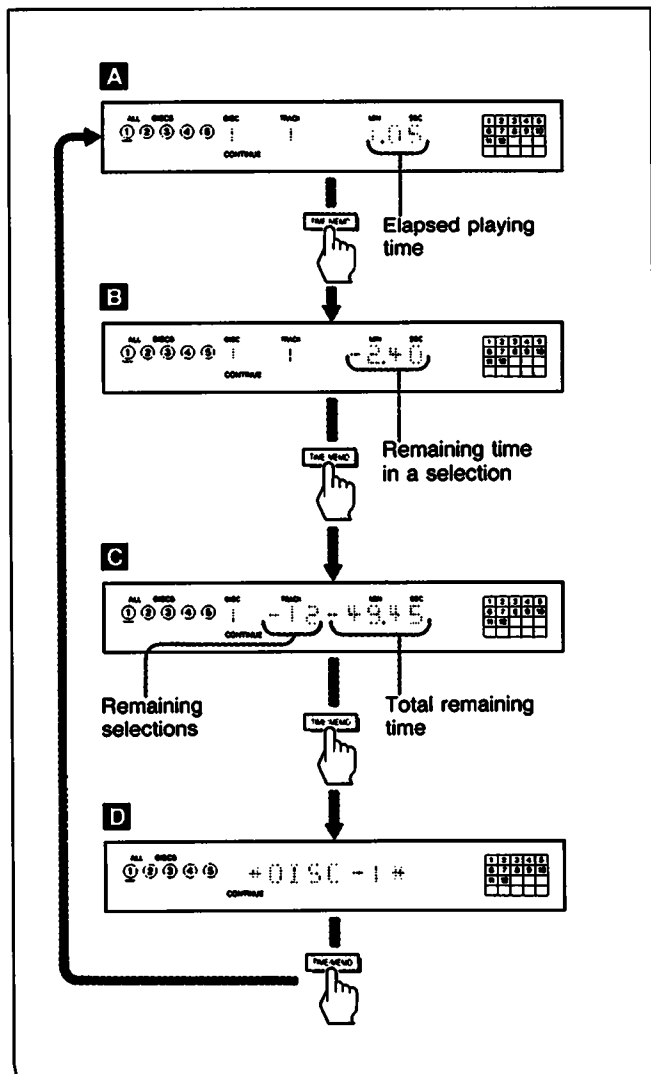

If you press TIME/MEMO during play, the display changes to give you the following information:

- A** Elapsed playing time of the selection in the manner you choose during the stop mode. It automatically displayed when play begins.
- B** Remaining time in a selection. Selection numbers up to 20 are also displayed at the bottom of the display window. If the track number is larger than 20, "--.--" appears instead of the remaining time display.
- C** Remaining time and remaining selections of the disc (displayed only in the continue mode). When the time fade function is activated, remaining time and remaining selections until the fading out will be displayed.
- D** Disc memo or disc number.

Notes

- Total remaining time is only available during continuous mode. It will not be displayed by pressing the TIME/MEMO button during program, bank or shuffle mode.
- Total remaining time will be displayed, if time fade is set during program, bank or shuffle.

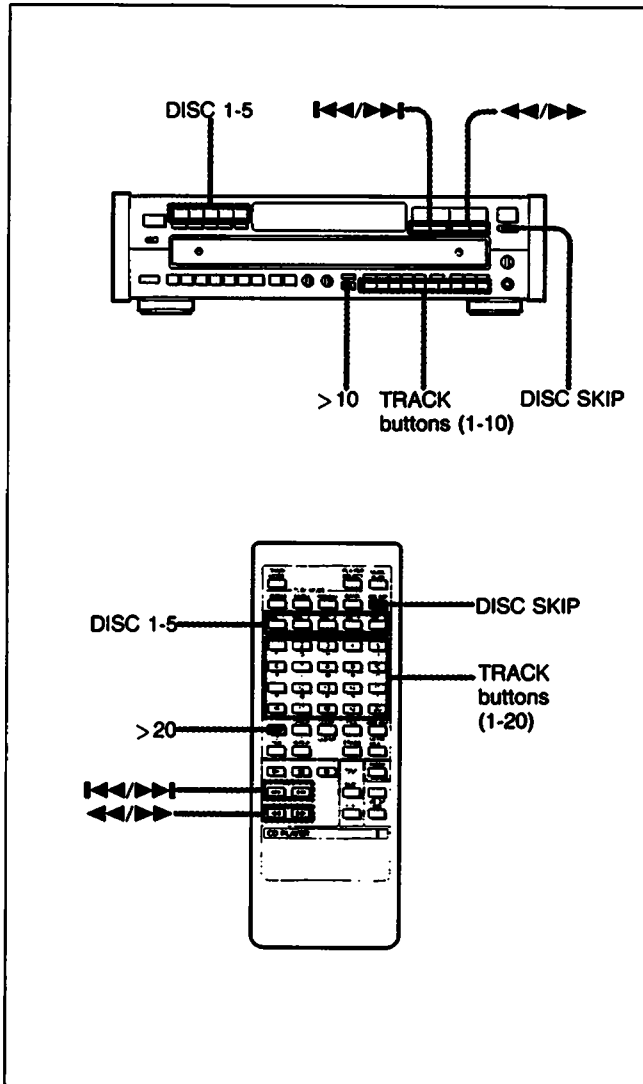

Selecting a Desired Disc

By using the DISC selectors or the DISC SKIP button during play, you can locate the beginning of any disc.

To select a particular disc	Press the corresponding DISC 1 to 5 button.
To move to the disc tray next to the current one	Press DISC SKIP.

Locating a Particular Selection

Locating a selection in sequence (Automatic Music Sensor)

You can locate the beginning of a selection on the disc being played.

To locate the beginning of the selection being played	Press ⏮ once.
To locate the beginning of the next selection	Press ⏭ once.

Continue to press until the selection you wanted has been located.

To locate directly

Press one of the track buttons to enter the desired selection number.

- **[1]** to **[10]** on the main unit.
To enter a number greater than 10, use the **[>10]** button.
- **[1]** to **[20]** on the remote commander.
To enter a number greater than 20, use the **[>20]** button.

e.g. To play from selection No.22

Press **[>10][2][2]** or **[>20][2][2]**.

To play from selection No.30

Press **[>10][3][10]** or **[>20][3][10]**.

[10] functions as the figure 0.

Locating a Particular Point in a Selection

You can locate a particular point in the disc during play.

To search quickly while monitoring the sound

To go ahead at high speed

Keep **⏭** pressed during play and release at the desired point.

To go back at high speed

Keep **⏮** pressed during play and release at the desired point.

To search quickly by observing the display

Press **⏏** then keep **⏭** or **⏮** pressed. The search speed will increase, but there will be no sound. Find the desired point by observing the display.

Press **▶** or **⏏** again at the desired point.

If you continue to press **⏭** or **⏮**.

If you continue to press **⏭** once the end of the disc has been reached, “- OVER -” appears in the display window. Press **⏮** or **⏮** to return to the normal display.

Playing in a Random Order – Shuffle Play

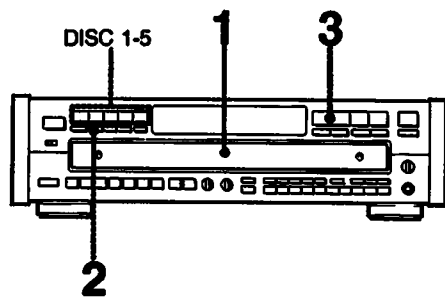

1

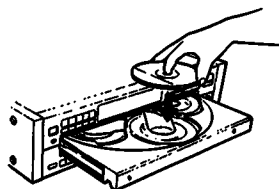

2 Choose whether to play one disc (1 DISC) or all discs (ALL DISCS).

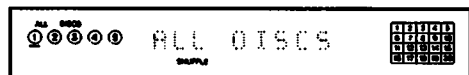

3

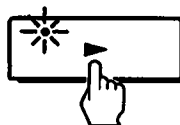

When all selections of a disc are played, the circle on the tray number goes off.

You can have the selections played in a random order (up to 99). The unit will play all the discs or just disc(s) you desire.

Once a selection is played, it will not be played again until the random order is completed.

To stop play

Press ■.

To cancel shuffle play

Press CONTINUE and return to the continuous playing mode.

To select a desired disc during "1 DISC" shuffle play

Press the desired DISC 1-5 buttons. A circle will appear around the selected disc.

To Play Only the Desired Discs in a Random Order – Select Shuffle Play

You can select the desired discs during the stop and play modes. (ALL DISCS mode)

To select the desired discs

Press the DISC 1-5 buttons. Circles appear around the selected disc numbers to be played.

To delete a disc which you have selected

Press the applicable DISC 1-5 button. The circle around the selected disc number will disappear.

You cannot put off a circle around the number of the disc being played.

If you press SHUFFLE during play (except for shuffle play)

Shuffle play begins from the current selection.



What is this indication?

This indication appears while the player is shuffling the selections.

Playing in a Desired Order – Program Play

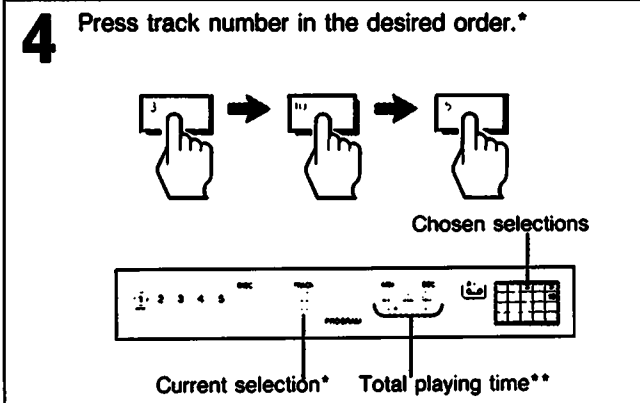
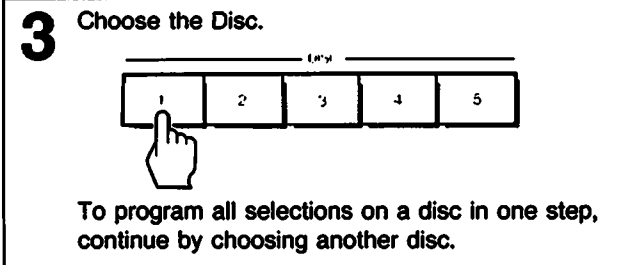
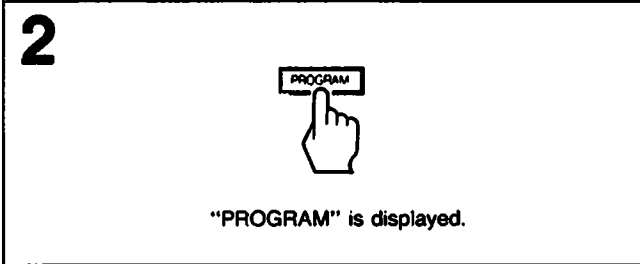
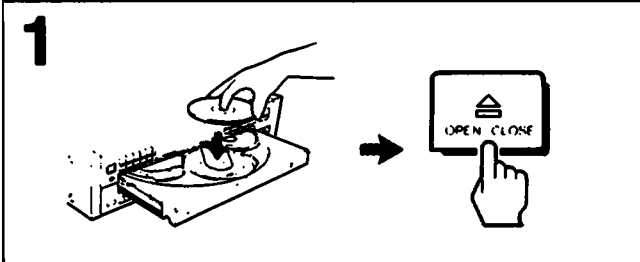
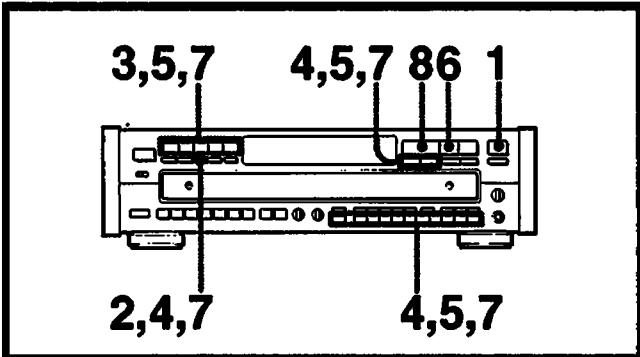

* To choose a track number over 10 (or 20), see page 10.
 If you have programmed a selection number over 20, numeric of STEP is displayed instead of the total time.

Designating the Playing Time – Program Edit

A Choose selection and check the time.

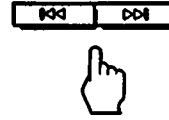

Press **◀▶** repeatedly to choose an appropriate selection.

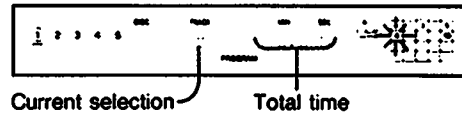

B A satisfactory selection has been chosen.



The selection is stored, and the flashing numbers in the window lights up.

5 To program additional selections from the same disc, repeat step 4.
 To program additional selections from another disc, repeat steps 3 and 4.

6 If you program the selections for side B, insert a pause.

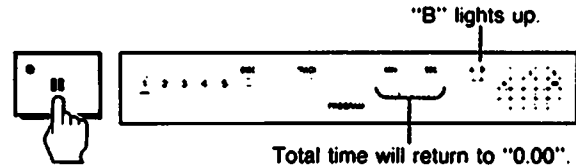

7 Program the selections for side B.
 Repeat steps 3 to 4.

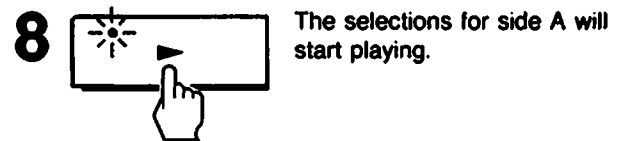

** It may take time for the total playing time of the program to appear. Also, if the total playing time exceeds one hour, the current selection indication will be used to display the hour unit.

You can make a program by designating up to 32 selections in the order you want them to be played. The unit will play the disc according to your program.

You can make a program for both sides (side A and side B) of the tape at one time.

You can program one selection or one disc in a step.

To play the selection for side B

When the selections for side A have been played, the unit will pause. ("B" will light up.)

Set the tape to the beginning of side B, then press ► or ■. The selections for side B will start playing.

Adding selections to a program during program play

- 1 Press the desired disc button while the unit is in the play or pause mode.
- 2 While the step display appears, press the TRACK buttons which correspond to the selection number you want to add.

To stop program play

Press ■. The last selection number programmed is displayed.

To resume play, press ►. Play begins from the beginning of the program.

You can play the same program repeatedly as long as you do not cancel program play or erase the program.

To cancel program play

Press CONTINUE and return to the continuous playing mode. The program will be erased.

Skipping to the next selection programmed

Press ►► during play.

Going back to the beginning of the selection being played

Press ◀◀ during play.

Display on step 3 (procedure step display):

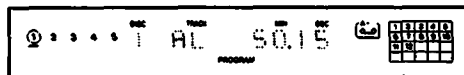

Checking the Programmed Selections

Press CHECK

The disc, track, and program numbers of the first selection in your program will be displayed.

Each time you press CHECK, the next selection in the program will be displayed.

When CHECK is pressed after the last selection, "– END –" appears and then the display returns to the initial display.

Clearing the Programmed Selections

Clearing the whole program

Press ■ once during stop, or twice during play. All the selections will be cleared.

Clearing the last selection in a program

Press CLEAR during stop.

The last selection will be cleared each time CLEAR is pressed.

Clearing a specific selection

- 1 Press CHECK repeatedly until the selection to be cleared is displayed.
- 2 Press CLEAR while the selection number is displayed. The selection will be cleared from the program.

The whole program will also be cleared in the following situations

- ⏻ is pressed.
- Power is turned off.
- Select other play modes.

To check the step of programmed selections

Press TIME/MEMO during stop mode.

The number of programmed selections will be displayed for few seconds in the window.

To check the remaining time of the selection being played

Press TIME/MEMO once to see the remaining time of the selection being played; twice to see the disc memo or disc number; three times to return to the initial display.

The total remaining time cannot be displayed.

If you have programmed a selection number over 20, --- is displayed instead of the remaining time.

Note

When selections have been programmed for sides A and B, the total playing time displayed during stop mode will show the selections programmed for side B and the total playing time for side B.

Designating the Total Playing Time – Time Edit

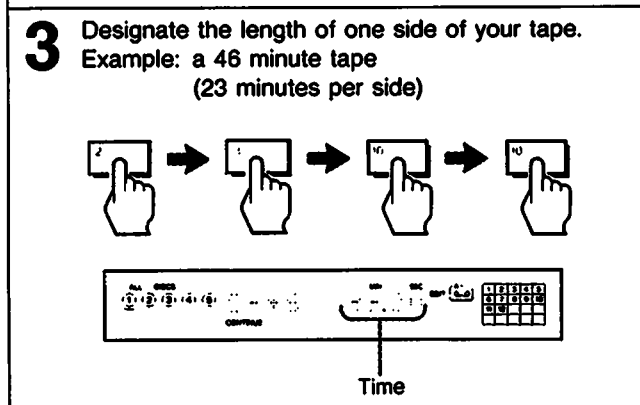
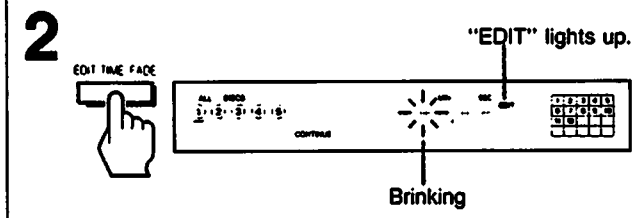
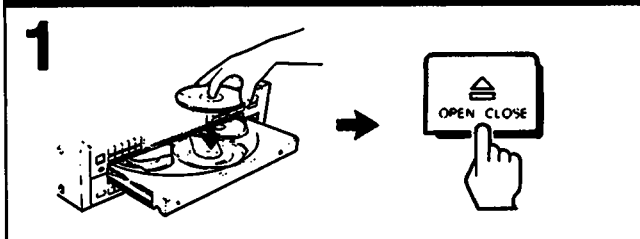
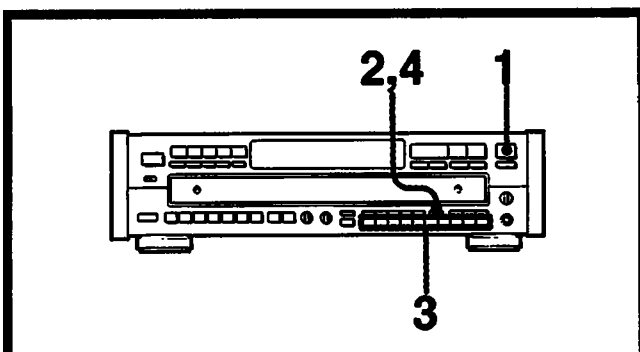

Press **[0]** for "0"
You need not press keys for seconds, unless required.
You can designate the tape length easily with the **◀◀/▶▶** buttons. Each time you press a button, the time changes in the following way.

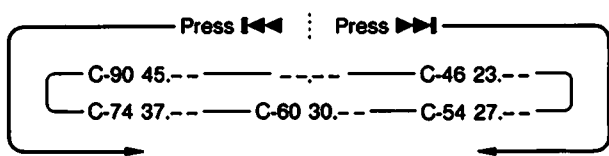

To set the seconds, press **◀◀/▶▶**. The time increases or decreases by 10 seconds.

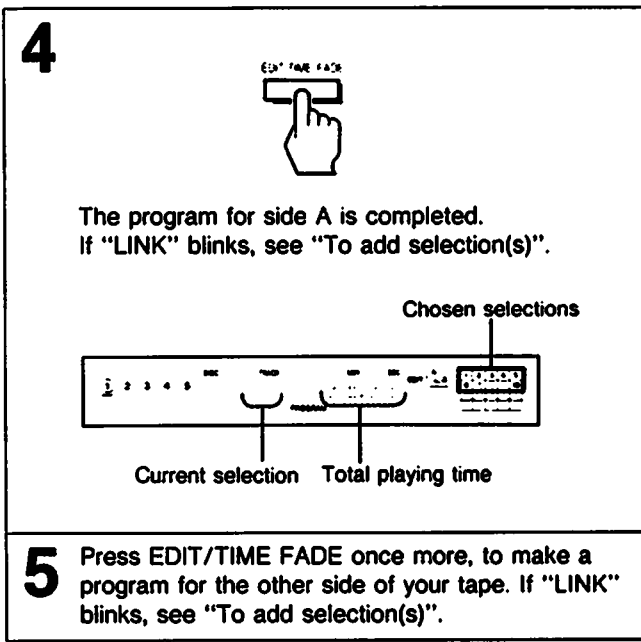

Note
The desired play duration can be set from 10 seconds up to 59 minutes 59 seconds.

You can designate a time and the unit will make 2 different programs of selections each fitting within that period. Use this function, by designating the length of your tape, for editing both sides of a tape.

To add selection(s) — LINK —

After all selections on the disc have been programmed, if there is selection(s) within the remaining time, "LINK" and the selection number(s) will blink.

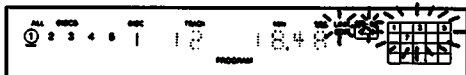

To add selection, press the numeric button for the selection number or press the EDIT/TIME FADE again. When pressing the EDIT/TIME FADE, a program will be made automatically to fit the playing time as close as possible to the remaining time.

If the remaining time can contain other selection(s), "LINK" and the selection number keep blinking. When "LINK" blinks, if the disc is changed by another disc, the new selection number(s) on the new disc that fit in the remaining time will blink.

"EDIT" disappears when the playing time becomes equal to the designated time. Whether "LINK" is blinking or not, you can change the disc by another disc and choose selection(s) to fit the remaining time.

To disappear "EDIT" in the window, press ■ button.

To play the program

Press ►.

The selections for side A will be played and then the unit will pause. "B" lights up in the tape side indicator. Set the tape to the beginning of side B, then press ► or ■■.

The selections for side B will be played.

Note

Playback can be performed when "EDIT" is displayed.

To stop playing

Press ■.

You can play the same program repeatedly as long as you do not erase the program.

To cancel time edit

Press CONTINUE and return to the continuous playing mode.

The program will be erased.

To erase the entire program

Press ■ once during stop; twice during play.

Press ■ twice when "EDIT" appears in the display during the stop mode.

The program is also erased, when you turn off the unit, or press ▲.

To include desired selections in the program

1 Make your own program of the desired selections. See page 12 for instructions.

2 Follow the procedure as shown on the preceding page. Just designate the length of your tape; you need not subtract the length of your program. The unit will place your selections at the beginning of its program and add other selections to fit the remaining time.

Checking the programmed selection

See page 13.

To designate a different time for each side

Execute steps 1 to 4 and press ■■. Then repeat steps 2 and 4. Do not execute step 5.

If your disc has more than 20 selections

- Selections over 20 cannot be programmed with the time edit function.
- If the program already contains a selection over 20, the time edit function will not work.

Notes

- Up to 32 steps will be programmed. Furthermore the time edit function cannot be used if your program has 32 steps.
- Time edit will not work for programs with total playing times exceeding one hour.

Convenient Features for Tape Recording

The following functions are convenient for editing your own tapes.

Time Fade and Fade in/Fade out cannot be operated when the DIGITAL (optical) OUT is used for connections.

Fading in/Fading out

You can have the play fade in and fade out between 2-10 seconds.

When no time is specified, the play will fade in and fade out for 5 seconds.

To set the fade time

- 1 Press **■**.
- 2 Press FADER. "FADE 5 SEC" will appear in the display window. The actual fade time "5" will be flashing.
- 3 Press **◀/▶** to select fade time between 2-10 seconds.
- 4 Press FADER.

To end the play fading out

Press FADER when you want to start fading out.

FADE flashes in the window, and play fades out and unit enters the pause mode.

To restart the play fading in

Press FADER in the pause mode.

FADE flashes in the window, and play fades in.

Fading out after a desired duration – Time Fade



You can have the play fade out at the end by designating the play duration. Once time fade is set, it functions twice for editing both sides of a tape. You can change discs without canceling this function. The fade time is preset to 5 seconds, but you can change it between 2-10 seconds.

To set time fade

- 1 Press EDIT/TIME FADE twice during stop.

FADE is displayed in the window.

- 2 Set the desired play duration, using numeric buttons.

e.g. To set to 27 minutes, press **[2][7][10][10]**.

You need not press buttons for seconds, unless required.

You can designate the tape length easily with the **◀/▶** buttons. Each time you press a button, the time changes in the following way.

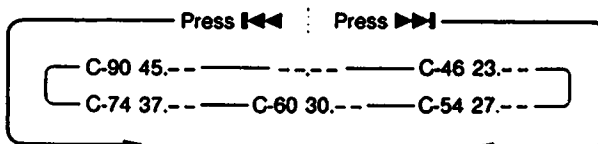

To set the seconds, press **◀/▶**. The time increases or decreases by 10 seconds.

Note

The desired play duration can be set from 10 seconds up to 59 minutes 59 seconds.

- 3 Press EDIT/TIME FADE.

- 4 To start play, press **▶**.

After the designated time, play fades out and pauses.

Tape side B lights up. Press **■** or **▶** to resume playing for the other side of the tape. If you press FADER, fade in will start. When the play fades out for the second time, the unit pauses and the time fade function is canceled.

When playback ends in the duration of time fade

Time fade function will be kept on. Change the disc and start playback automatically when the total playing time is within some seconds before the designated time, the player fades out.

To cancel time fade

Time fade will be canceled when

- EDIT/TIME FADE is pressed once again.
- **◀/▶** (manual search) is pressed during play.

To display the time remaining until the time set

Press TIME/MEMO twice.

If the PEAK SEARCH is pressed after setting time fade, time fade is released but peak search is kept active.

Locating the loudest portion of the disc – Peak Search

The CD player can search a disc from the beginning to the end and determine the loudest portion (peak level) of the disc, and then play that portion repeatedly. This function will make it easier for you to adjust to the optimum level when recording on tape.

This function operates in all play modes as follows:

Play mode	Operation
Continuous and shuffle modes	Searches all selections of the disc which is clamped currently
Program mode	Searches all programmed selections
Bank mode	Searches all selections stored in the program bank

Unless you are using the program mode, the unit will scan all discs that are clamped, even in the ALL DISCS mode.

To activate the peak search

Press PEAK SEARCH during the stop mode.

“PEAK” flashes in the display and the all selection of the disc or program will be searched automatically. After finishing the search, the loudest portion is played repeatedly for 4 seconds and “- PEAK -” appears.

Note

To go to another disc press DISC SKIP button during stop.

To start play immediately

Press ►. The play starts from the beginning of the disc.

To stop the peak search

Press ■.

Note on peak search function

The unit determines the loudest portion (peak level) of a disc by searching it at fixed intervals. As a result, the portion searched may differ from the actual peak level. In addition, this function may determine different portions as the peak level for the same disc. However, the difference between the portion searched and the actual peak level is insignificant and will not present any problem in adjusting the recording level.

Playing Repeatedly – Repeat Play

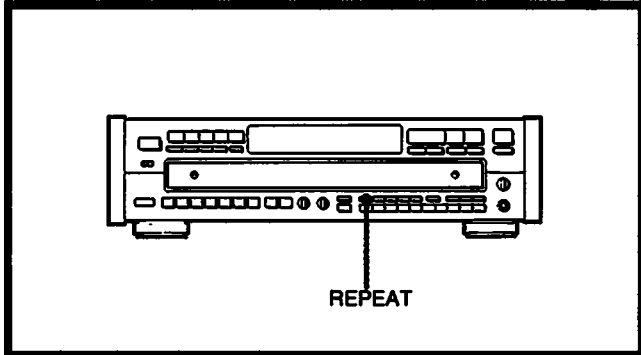

Press before or during play.



"REPEAT" appears. The unit repeats the current playing mode. To repeat a single selection, press REPEAT again during repeat play of the continuous playing mode. "REPEAT 1" appears.

Repeat play can be used in any play mode to repeat a single disc or all discs in the unit. In the continuous play mode, you can repeat a single selection.

Playing mode	Selections played
Continuous play (ALL DISCS)	All the selections on all discs, or the selection currently being played (REPEAT 1)
Continuous play (1 DISC)	All selections on the disc currently being played, or the selection currently being played (REPEAT 1)
Shuffle play	All selections on the disc (in the 1 DISC mode) or all discs (in the ALL DISCS mode) are reshuffled.
Select shuffle play	All selections on a selected disc are reshuffled.
Program play	Repeats all selections and/or programs in their programmed order.
Bank play	Repeats all selections stored in the bank in their programmed order (or all selections if the disc does not have a bank file).

To cancel repeat play

Press REPEAT again.

"REPEAT" disappears.

To cancel repeat play of the continuous play, press REPEAT twice. "REPEAT" disappears.

Playing the Beginning of Each Selection – Music Scan

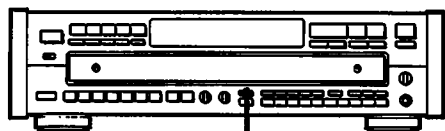

MUSIC SCAN

Press during stop.



To change the playing time

Press MUSIC SCAN again.

Each time you press MUSIC SCAN, the display will be as follows:

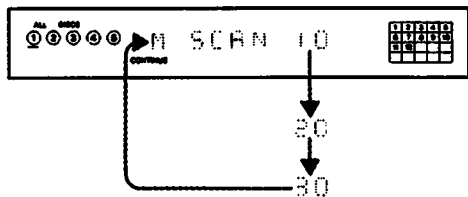

The indicator on the ► button blinks and beginning of each selection is played for 10, 20 or 30 seconds as designated and fades out.

You can check the selections by scanning the beginning of each selection on the disc. When "ALL DISCS" is selected in continue mode, the first selection of each disc will be scanned.

You can use this function in any play mode.

When scanning is finished,
the unit enters the stop mode.

To stop music scan play

Press ■.

Starting play at the selection being played during music scan

Press ►. The indicator on the ► button will lights up.

Notes

- Programmed pauses in program mode will be disregarded during music scan play.
- If you press the ◀▶ button, music scan will be canceled.
- Pressing the MUSIC SCAN button while the beginning of selection is being scanned will extend the playing time for 10, 20, or 30 more seconds.

Enhanced Surround Effects – Digital Signal Processor

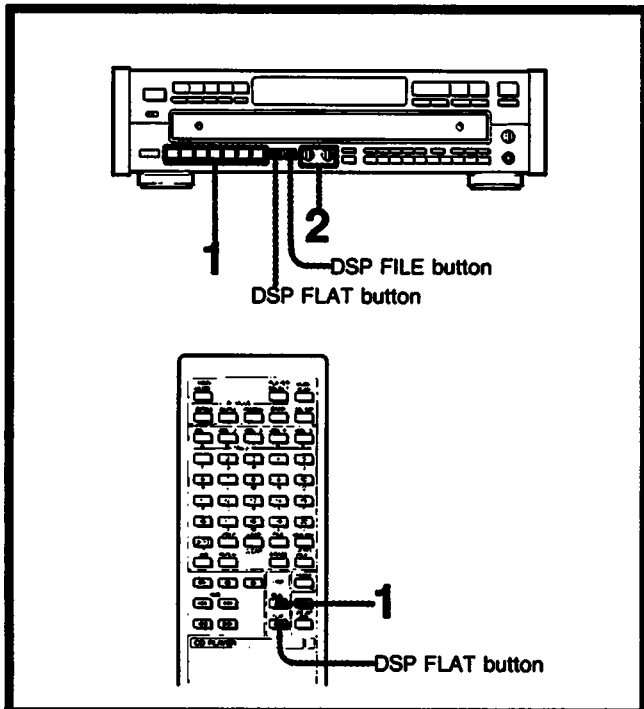

1 Choose the desired DSP mode

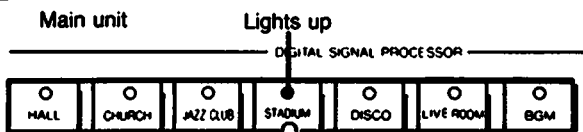

Remote commander



Each press this button will change the DSP mode as follows;

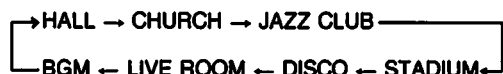

The indicator on the DSP mode select button lights up.

2 Adjust to the desired equalizer and reverb level*. (Cannot be controlled from the remote commander.)



The Digital Signal Processor (DSP) lets you listen to selections according to various acoustic atmospheres. These atmospheres are produced by a digital processing technique that involves simulating reflected and reverberated sound effects and digitally compensated frequency response. DSP modes can be stored in the memory of the player as a custom file. You can choose from the following processing mode.

DSP mode	Characteristic
HALL	Reproduces the acoustics of a 2,000 seat capacity concert hall.
CHURCH	Reproduces the acoustics of a church with solid walls, stained glass interior, and high roof.
JAZZ CLUB	Reproduces the acoustics of a modern jazz club.
STADIUM	Reproduces the acoustics of a 30,000 seat capacity out door stadium.
DISCO	Reproduces the acoustics of a discotheque and features strong reverberation with a dynamic bass.
LIVE ROOM	Expands the sound for ideal listening acoustics in small rooms or when using headphones.
BGM	Softens the sound for a background music effect similar to the acoustics of a hotel lobby.

*Adjusting the EQUALIZER level

The equalizer level adjusts the frequency response. Turning this knob toward MAX increases the frequency response, while turning it toward MIN lowers the frequency response.

*Adjusting the REVERB level

The reverb level adjusts the level of the Surround effect. Turning this knob toward MAX enhances the Surround effect. While turning it toward MIN reduces the Surround effect.

To cancel the DSP mode

Press the FLAT button. The DSP mode indicator will turn off.

Notes

- The DSP mode is back-up while the power is turned off.
- Noise may occur when switching DSP modes and Effect levels.
- When using the DSP mode, large outputs from the player may cause distortion from your amplifier. In this case, change the LINE OUT connections from FIXED to VARIABLE so that you can adjust the output level with the PHONE LEVEL/LINE OUT LEVEL control.

Memorizing a DSP Mode



The DSP modes, as well as the Equalizer and Reverb settings, can be stored in memory to correspond with a certain disc. By making a DSP file, you can insert or select a disc and have it played to a pre-selected acoustic atmosphere (See "On Custom Files" on page 22).

To make a DSP file

- 1 Play the applicable disc and select a DSP mode.
Adjust the Equalizer and Reverb controls as necessary.
- 2 Press the DSP FILE button. "DSP FILE" is displayed and CF DSP appear in the display.
The indicator on DSP FILE button will also light up as long as the DSP settings correspond with the DSP file.

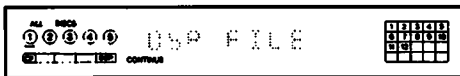

To change DSP files

Select a new DSP mode. Press the DSP FILE button. The new DSP mode will be stored in the DSP file.

To change DSP mode without erasing the DSP file

Select the desired DSP mode or adjust the Equalizer/Reverb level control as necessary. The indicator on the DSP FILE button will go out, indicating you have disabled the DSP mode specified in your DSP file and are now adjusting manually. The current mode will stay in effect until you change it again, or press the DISC SKIP button and changes discs. You can recall the DSP file by selecting the bank mode, if the bank is filed. The DSP FILE indicator will light up again.

Clearing a DSP file

- 1 Put the disc whose DSP file is to be cleared in the player. Press FLAT button.
- 2 Press the DSP FILE. "FILE ERASE" is displayed and "CF DSP" goes off from the display window.

About Surround Sound

There are three basic sound effects that produce the acoustics of concert halls and movie theater. Direct sound, early reflection, and reverberation. The acoustic quality of a room depends on how that room reproduces these three sounds.

Types of sounds

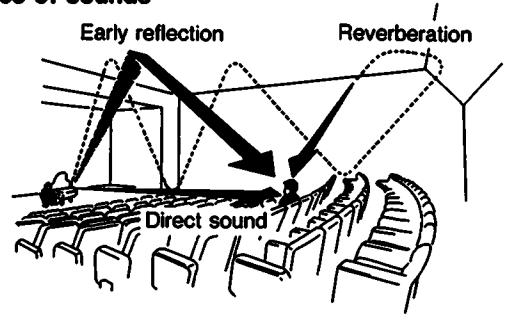

On Custom Files

The CD player is equipped with a memory which allows you to store three types of information called "custom files".

Up to 184 discs of Custom File can be retained in the unit's memory.

The four custom files you can store in memory

Disc memo	To store a name of up to 10 letters for an individual disc. (page 24)
Bank	To store a program in memory so it can be played again. (page 23)
Level file	To preset an output level of the headphones/variable line out jacks for an individual disc. (page 26)
DSP file	To store an acoustic atmosphere for an individual disc. (page 20)

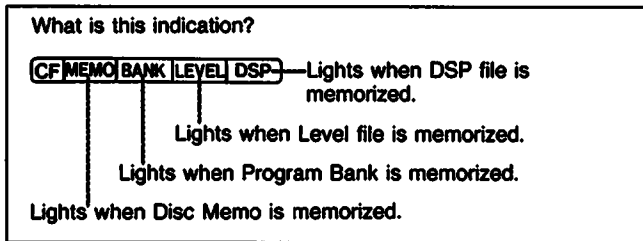

Memory backup for the custom files

Custom files, once memorized, are retained in the compact disc player's memory for approximately 1 month without AC power supply.

Since the memory is stored in the unit and not on the disc, you cannot perform custom file functions with the same disc on a different player.

What is this indication?

FILE FULL

This indication appears when FILE is pressed while no custom file can be memorized for the disc currently put in the player. To make a custom file for the disc, clear the custom file of another disc.

To clear custom files of all discs at once

Press POWER to turn on the unit (without discs on the tray) while keeping ERASE and FILE pressed. "ALL ERASE" will be displayed and all custom files are cleared.

To check the items of the custom files

Press TIME/MEMO (while "- NO DISC -" is displayed) without the disc(s) inserted. Each time you press TIME/MEMO, the items of the custom files and the items of the each column of **CF MEMO BANK LEVEL DSP** about the disc are displayed. If you press TIME/MEMO when the last disc's information is displayed, "- END -" is displayed and returns to "- NO DISC -" after a few seconds. To clear all custom files for a single disc, press TIME/MEMO repeatedly until the undesired custom file is displayed. Then press ERASE. "FILE ERASE" is displayed and **CF MEMO BANK LEVEL DSP** goes off in the display window.

Keeping the Program in Memory – Bank

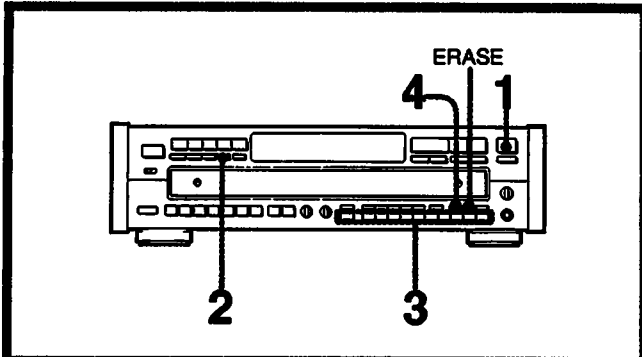

After programming selections, you can keep the program memorized, so that the disc is played always in the fixed order. The memorized program is called "bank."

Memorizing a Bank

The program is stored into the memory (One disc can memorize up to 24 programs). Only one bank can be made for a disc.

Notes

- You cannot program a whole disc under a single program number.
- To pause during the bank play, press **||** instead of step 3.
- If you press a DISC button during the stop mode, the bank stored for the disc is displayed.

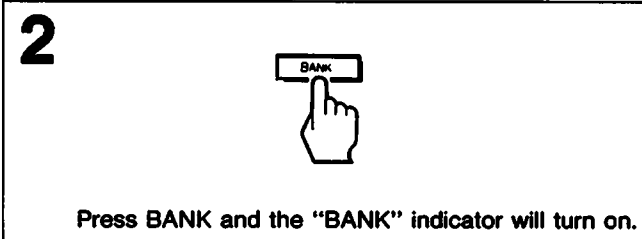
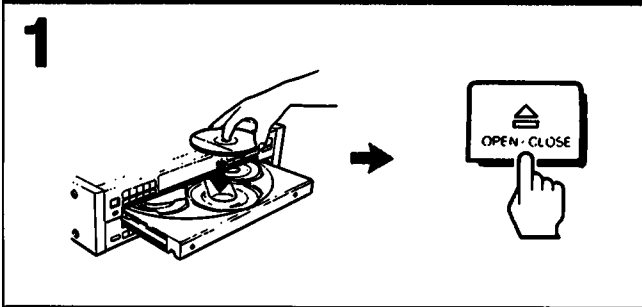

Press BANK and the "BANK" indicator will turn on.

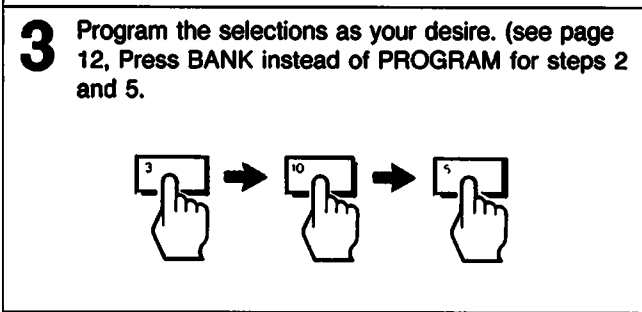

3 Program the selections as your desire. (see page 12, Press BANK instead of PROGRAM for steps 2 and 5.)

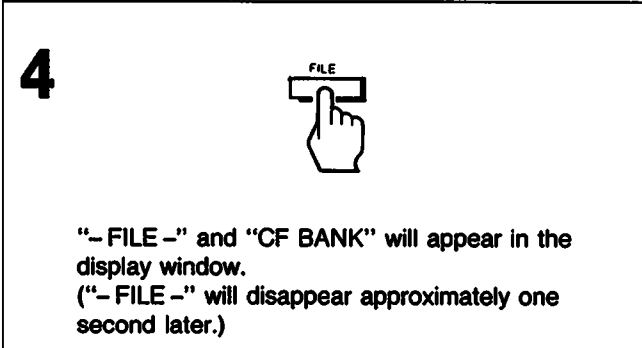

"- FILE -" and "CF BANK" will appear in the display window. (" - FILE -" will disappear approximately one second later.)

Playing the Disc Using the Bank

- 1 Press BANK to choose whether to play "1 DISC" or "ALL DISCS".
- 2 Press **⏏** to insert the disc having the bank. "CF BANK" appears in the display.
- 3 If you choose the "1 DISC" mode, press the DISC selector which corresponds to the disc you want.
- 4 Press **▶** to start play. When playing in the ALL DISCS mode, any disc without a bank file will be played in its entirety.

Clearing the Bank

- 1 Put the disc whose bank is to be cleared in the player. Then close the disc tray by pressing **⏏**.
- 2 Press BANK.
- 3 Press ERASE.
"FILE ERASE" is displayed and "CF BANK" goes off from the display window. The bank is cleared.

Assigning Names to a Disc – Disc Memo

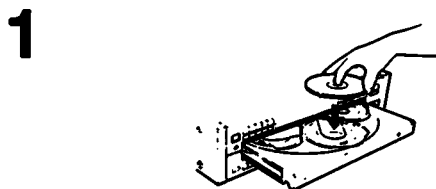
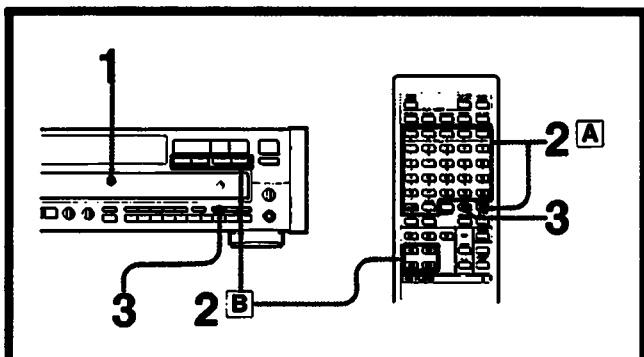

1 Make sure that the total number of selections and the total playing time are displayed. Then proceed as follows in the stop mode.

2 **A** Using the MEMO INPUT button with the letter buttons on the remote commander (This function can be entered while playing)



Each time you press MEMO INPUT, the display changes as shown above. Choose the desired capital letters, or numbers.

2 Press the applicable letter button.

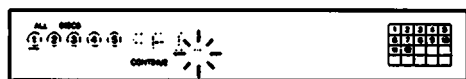
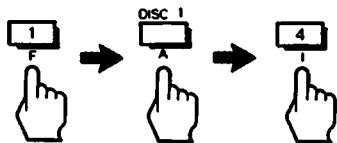

Move the cursor to select the next letter.

To change to numbers, return to the step **A**-1.

B Using the ◀▶ buttons

1

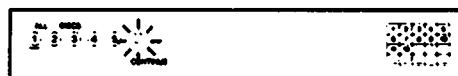
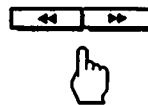

Press ◀ or ▶ until the desired letter appears.

Example: if ▶ is pressed 7 times, F appears.

2 When the desired letter appears, press ▶▶.

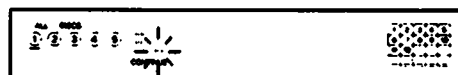
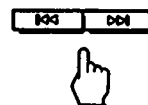

Move the cursor to select the next letter.

Repeat steps **B**-1 and **B**-2.

3

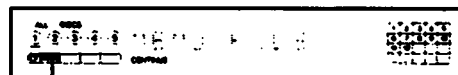

Lights up.

After about 1 second, the memo you have written will be displayed.

Each time the disc is put in the unit, the memo will be displayed.

Note

Symbols cannot be entered with the letter buttons on the remote commander. To enter symbols, use ◀▶ buttons.

Using the disc memo function, you can assign a name within 10 letters for each disc. The memo appears in the window every time you put the disc in the player. One name can be assigned for one disc. You can also assign a title for the “- NO DISC -” display (see page 8) using the same procedure as that for the disc memo.

Usable letters and symbols

For the disc memo, 46 letters and symbols and a space can be used. When the ◀▶ button is pressed for the first time, the space appears. Each time ▶▶ is pressed, letters and symbols will appear in the following order.

(space) A B C D E F G H I J K L M N O P Q R S T U V W X Y Z ' & : . < > * / + 9 8 7 6 5 4 3 2 1 0 -
--

Use ◀◀ to call up a previous character.

To rewrite letters or symbols

Before pressing FILE

Move the cursor under the letter/symbol to be changed and then select the desired letter/symbol using ◀◀/▶▶ or letter buttons on the remote commander.

To erase the letter and make space, locate the desired place with ◀◀▶▶ and press CLEAR.

After pressing FILE

Repeat from step 2.

If you want to assign names while referring labels

- 1 Place the disc(s) on the disc tray and keep the tray opened.
- 2 Follow step 2 to create a name for the disc.
- 3 Press DISC SKIP to select another if you want to assign two or more discs.
- 4 Repeat step 2 until you assign the all desired discs.
- 5 Press FILE. The disc tray closes automatically and “MEMO FILE” appears in the display window. The name for each disc has been assigned at once.

Note

Disc memos can also be changed while playing a disc by pressing the MEMO INPUT button on the Remote Commander.

Displaying the Memos

To display the memo for the disc being played

Press TIME/MEMO twice during the shuffle, program or bank mode and three times during the continuous mode. To return to the normal display, press TIME/MEMO once more.

Clearing the Disc Memo

- 1 Put the disc whose memo you want to clear in the player, and close the disc tray.
- 2 Press ◀◀/▶▶ or MEMO INPUT on the remote commander.
The blinking cursor will appear.
- 3 Press ERASE.
“FILE ERASE” is displayed and “CF MEMO” goes off from the display window.

Preset the desired Output Level to a Disc – Level File

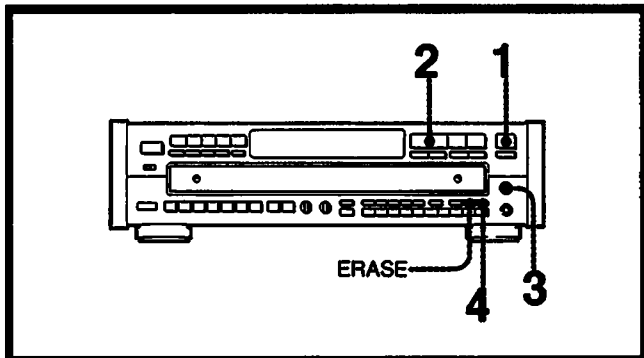

1

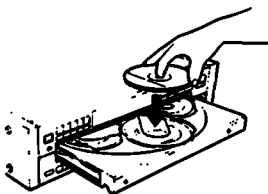

2

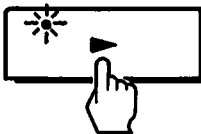

3



Adjust the level. You can also use LINE OUT LEVEL buttons on the remote commander.

4



"LEVEL FILE" and "CF LEVEL" appears in the display window.

Using the level file function, you can preset the desired output level for each disc. When a disc with the level file is played, the PHONE LEVEL/LINE OUT LEVEL control on the front panel is automatically adjusted to the preset level.

When you use the level file function, use headphones or the amplifier connected to the variable line output jacks. This function does not work for the output level of the fixed line output and optical digital output jacks.

To preset a new level on to the current level file
Repeat steps 3 and 4.

Clearing the Level File

- 1 Put the disc whose level file is to be cleared in the player.
- 2 Press DISC button which corresponds to the disc whose level file you want to clear.
- 3 Press LEVEL FILE. "LEVEL FILE" appears in the display.
- 4 Press ERASE while the "LEVEL FILE" is displayed. "FILE ERASE" is displayed and "CF LEVEL" goes off from the display window. The level file setting is cleared.

Timer Activated Playing

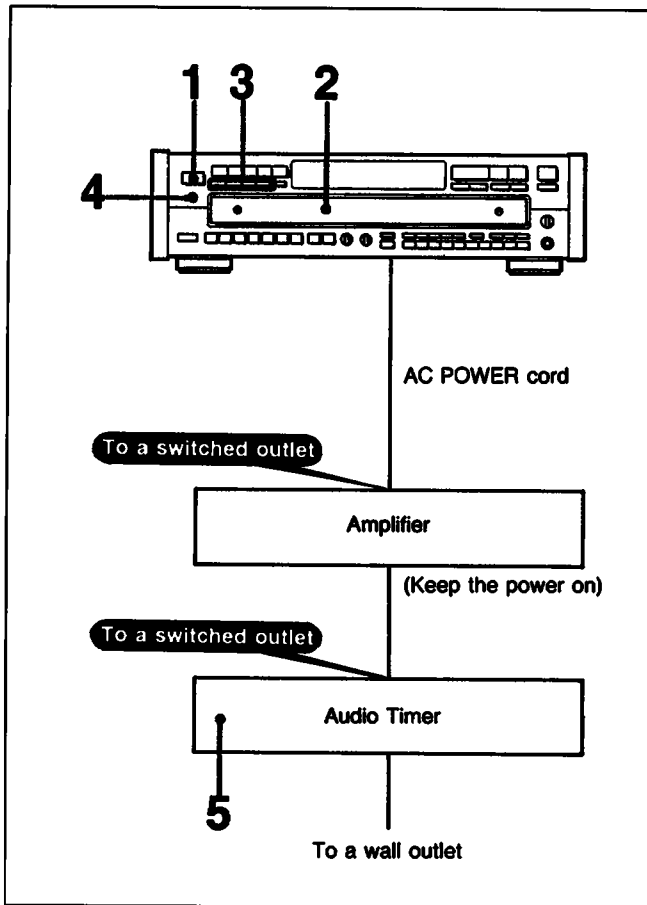

By connecting a commercially available timer, disc play can be started at any desired time.

Activating the Power with an Audio Timer

1 Press POWER to turn on the unit.

2 Put disc(s) on the disc tray.

3 Choose the desired play mode.

Note: you cannot choose the program mode for timer activated playing.

4 Set the TIMER to PLAY.

5 Set the turn-on time of the audio timer.

When the timer play ends

Be sure to set TIMER to OFF.

Note

If two CD players are connected in a serial chain, turn the TIMER switch on for one player only.

Connect Two Players and for More Listening Enjoyment – Serial Chain Control (CDP-C87ES only)

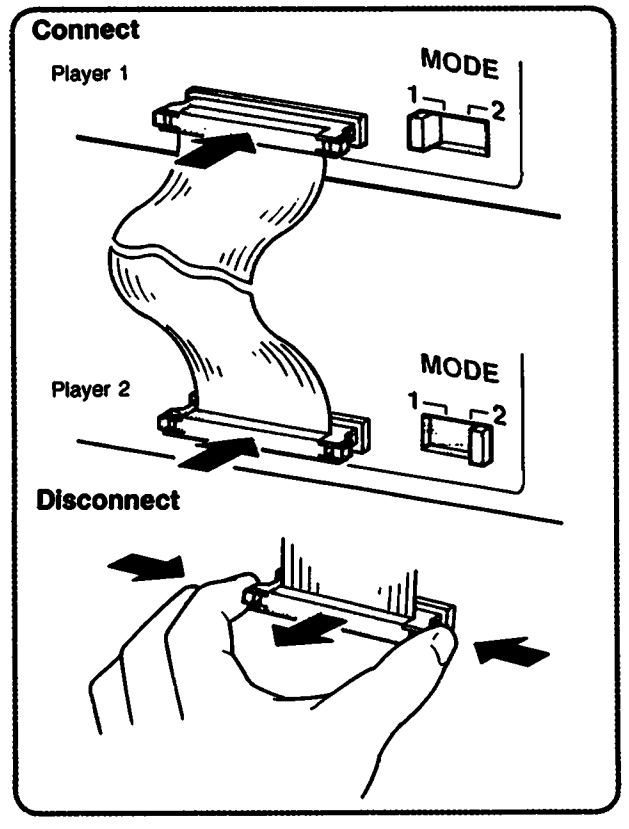
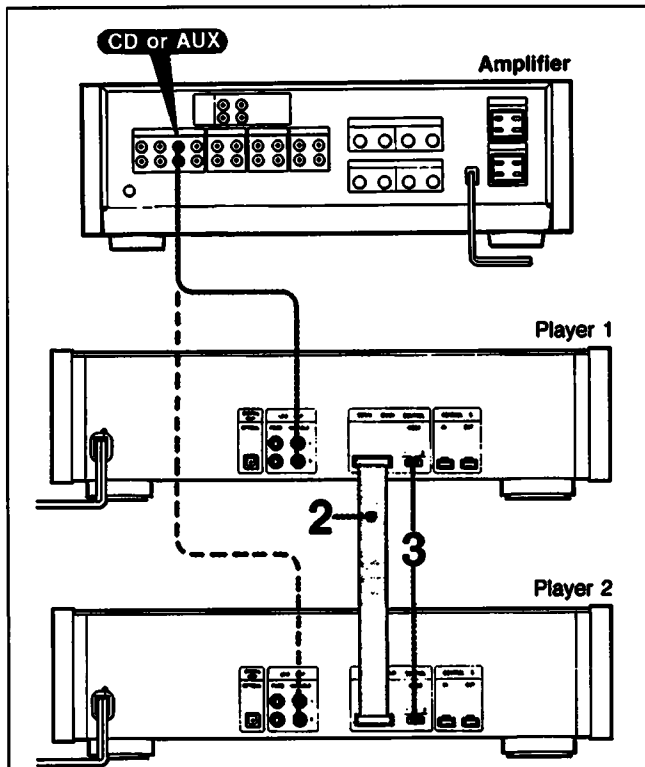

The serial chain control feature allows you to play from two different players. You will need another CD player that supports the serial chain function.

The following three modes are available.

CHAIN mode – Each player takes turns playing either discs.

RELAY mode – After all discs in the first player have been played, the discs in the second player are played.

OFF mode – Disables the serial chain mode to play either player alone.

	CHAIN	RELAY
Continuous play Bank play	Each player takes turns playing one complete at a time.	After all discs in player 1 (or 2) are played, the discs in player 2 (or 1) are played.
Shuffle play Select shuffle play	Each player takes turns playing discs. Discs are exchanged after playing all shuffled selections on that disc.	After all discs in player 1 (or 2) are played, all the discs in player 2 (or 1) are played.
Program play	Not available in the chain mode.	After all selections programmed (or stored in the bank) for player 1 are played, all the selections programmed (or stored in the bank) for player 2 are played.

Repeat play is available with serial chain operation. However, you can repeat a single selection in the continuous play mode.

Notes

- The 1 DISC mode is not available in the serial chain mode.
- Music scan will only work with one player.

To Connect

Be sure both players are turned off before connecting them.

- 1 Turn the power off to both players.
- 2 Connect the players with the serial chain cable supplied with either player.
- 3 Set the SERIAL CHAIN CONTROL MODE selector switch on player 1 to 1. Set player 2 to 2.

To use the CONTROL S feature, connect as follows.

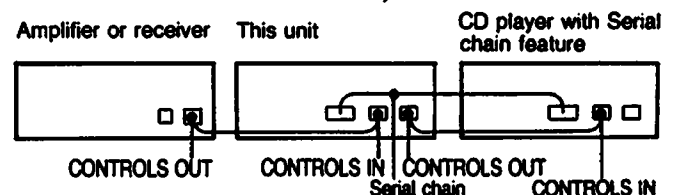

Notes

- The LINE OUT signal to your amplifier can be connected to the FIXED or VARIABLE jack on either player 1 or player 2.
- Audio optical connecting cord cannot be used to connect both players. Set the function mode on your amplifier to ANALOG IN.

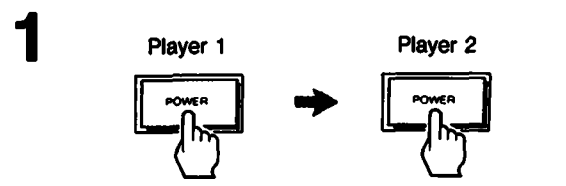
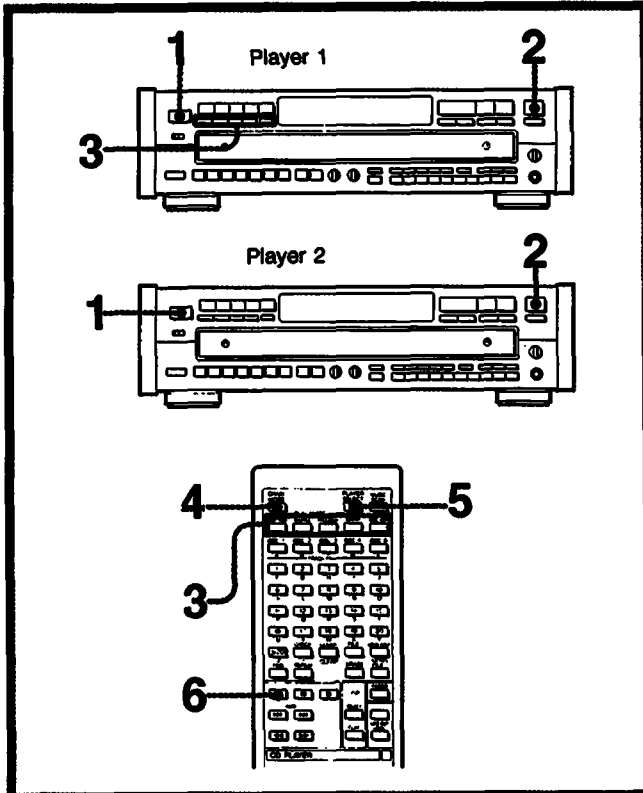

The player turned on first will have a brighter display window. This player plays first.

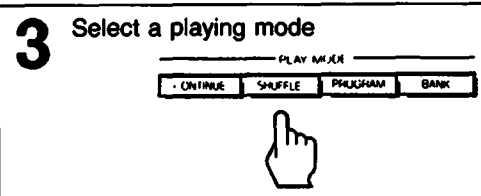
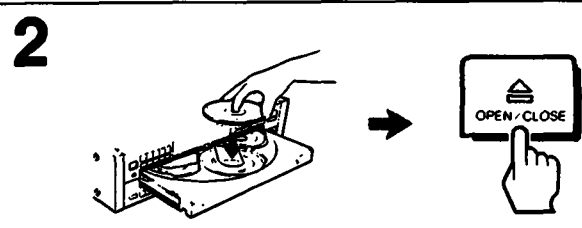

- Select the desired mode on the player with the brighter display.
- If you select the program mode, continue by making your program. (See page 12)

4 Select a chain mode on the remote commander (Not available on the main unit)

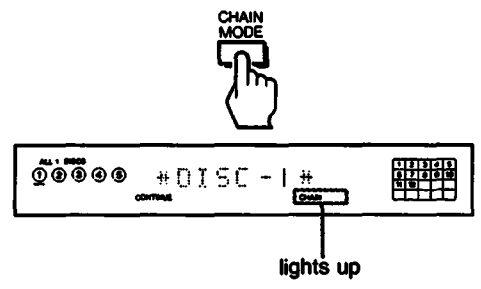

Each press of the CHAIN MODE button changes the display as follows.

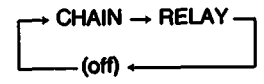

5 Select the player you want to play first



The display window on the selected player will appear brighter than the other player.



- Notes**
- If BANK is selected, any disc not having a bank file will be played continuously.
 - The PEAK SEARCH and PLAY MODE buttons are disabled on the player with the darker display window.
 - EDIT/TIME FADE is not available.
 - You cannot connect a headphone to player that is turned off. However, the output from LINE OUT is available.
 - Adjust the PHONE LEVEL/LINE OUT LEVEL and DSP modes on the player operating at that time.
 - The Remote Commander will only work with the player with the brighter display. To change players, press the PLAYER SELECT button on the Remote Commander.
 - The DISC SKIP button on the player with the darker display will not work while shuffle play mode in the Chain or Relay modes.

Specifications

Compact Disc Player

Frequency response	2 Hz – 20 kHz (± 0.3 dB)
Signal to noise ratio	More than 110 dB
Dynamic range	More than 100 dB
Harmonic distortion	Less than 0.0025% (CDP-C87ES/C77ES)
Channel separation	More than 105 dB
Outputs	
LINE OUT (FIXED) (phono jacks)	Output level 2 V (at 50 kilohms, non DSP mode) Load impedance over 10 kilohms
LINE OUT (VARIABLE) (phono jacks)	Output level max 2 V (at 50 kilohms, non DSP mode) Load impedance over 10 kilohms
DIGITAL OUTPUT (OPTICAL) (optical output connector)	Wave length 660 nm Output level –18 dBm
HEADPHONES (stereo phone jack)	Output level max. 15 mW Load impedance 32 ohms
General	
Power requirements	USA model: AC 120 V, 60 Hz Australia model: 240 V AC, 50/60 Hz
Power consumption	18 W
Dimensions (w/h/d)	Approx. 470 × 125 × 385 mm (18 ⁵ / ₈ × 5 × 15 ¹ / ₄ inches) (CDP-C87ES/C77ES) Including projecting parts and controls
Weight	Approx. 9.4 kg (20 lbs 12 oz), net (CDP-C87ES) Approx. 8 kg (17 lbs 11 oz), net (CDP-C77ES)

Remote Commander RM-D715 (CDP-C77ES supplied) RM-D870 (CDP-C87ES supplied)

Remote control system	Infrared control
Power requirements	3 V DC with two size AA batteries (IEC designation R6)
Dimensions	62 × 20 × 175 mm (w/h/d) (2 ¹ / ₂ × 1 ³ / ₁₆ × 7 inches)
Weight	130 g (4.6 oz) including batteries

Supplied Accessories

Connecting cord
(2 phono plugs ↔ 2 phono plugs) (1)
Serial chain cable (1) (CDP-C87ES only)
CONTROL S cable (1) (CDP-C87ES only)
Remote commander (1)
Size AA batteries (2)
Screws (1 set)

Optional Accessory

Audio optical connecting cord POC-15

Design and specifications subject to change without notice.

Troubleshooting Guide

The following checks will assist in the correction of most problems which you may encounter with your unit. Should any problem persist after you have made these checks, consult your nearest Sony service facility. Before going through the check list below, first refer back to the connection and operating procedures.

Trouble	Causes	Remedy
No audio from one or both channels	Incorrect operation of the amplifier	Operate correctly.
	Loose connection	Connect the cords firmly.
Play does not begin.	No disc in the disc compartment	Put disc(s) in the compartment.
	The player is in the pause mode.	Press ► or to release pause.
	Moisture condensation	Leave the player turned on for about an hour.
	The disc is set upside down.	Set the disc with the label side up.
	The disc is tilted.	Set the disc correctly.
	The disc is extremely dirty.	Clean the disc.
Remote commander does not operate the unit.	The batteries are exhausted.	Replace both batteries.
	The remote commander is not pointed at the remote control sensor.	Point the remote commander to the sensor.
	There is an obstacle between the remote commander and the unit.	Remove the obstacle.
	The remote commander is too far from the unit.	Move closer.
Any operation is not possible.	The internal control program may not run.	Turn off the power and turn it on again.

Note

This unit uses several micro-computer chips to control a series of operations. Sometimes, an operation may not work properly due to the condition of the power being supplied. In this case, turn the power off, then turn it back on and retry the operation.

